

CTS - 90RF1

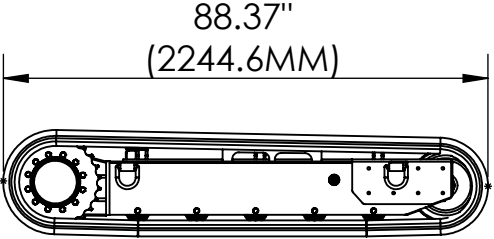
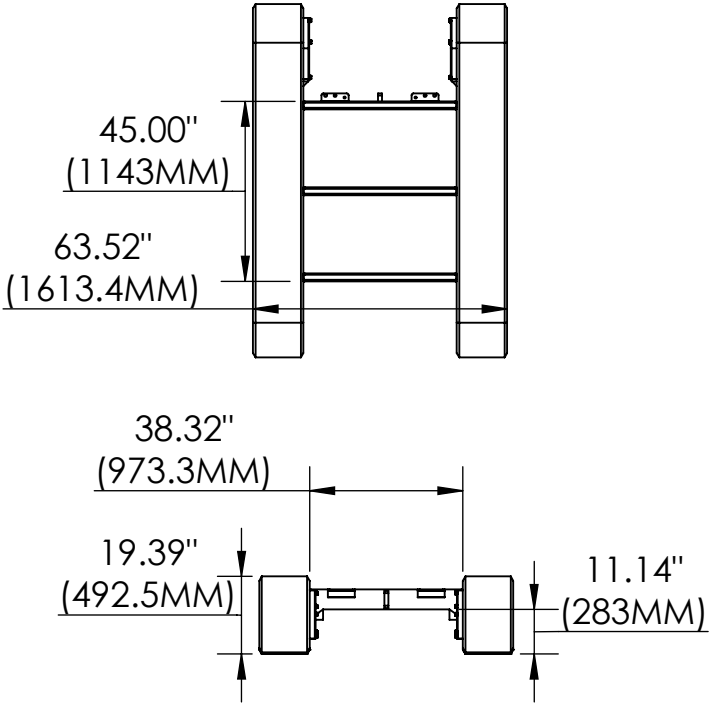

SPECIFICATIONS

MOTOR	OPEN LOOP	GPM PER MOTOR	GEAR RATIO	MAX GVW	MPH
4B	2 SPEED / W BRAKE	20 @ 3500 PSI	47.53 : 1	13,000 LBS	L 1.7 / H 2.8
HT 4B	2 SPEED / W BRAKE	20 @ 3500 PSI	58.4 : 1	15,000 LBS	L 1.34 / H 2.56