

CTS-78R

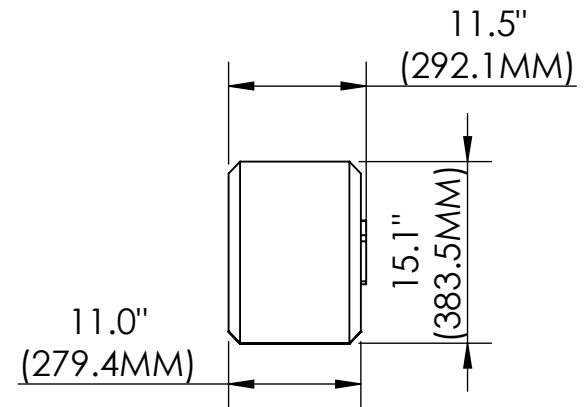

SPECIFICATIONS

MOTOR	OPEN LOOP	GPM PER MOTOR	GEAR RATIO	MAX GVW	MPH
3B	2 SPEED / W BRAKE	11 @ 3500 PSI	45.2 : 1	8,000 LBS	L 1.31 / H 2.48